



Methode
Power Solutions
Group

Power Distribution Bus Bars
Flexible Power Cables and Assemblies
Power Interconnects
Thermal Management Solutions
PowerRail

SCR CLAMP EXTRUSIONS

Product ID	Width		Height		Surface Area		Mass		Thermal Rating @ 3" LG		Profile pic and thermal curves
	(in)	(mm)	(in)	(mm)	(in/in)	(mm/mm)	(lb/ft)	(kg/m)	Natural Convection (°C/W)*	Force Convection @ 400 LFM (°C/W)**	
VA3	6.000	152.40	6.875	174.63	140.88	3578.35	14.57	21.67	0.5		click here
VA31	6.000	152.40	6.875	174.63	148.60	3774.31	14.02	20.87	0.49		click here
VA32	6.000	152.40	6.875	174.63	149.10	3787.01	14.02	20.86	0.48		click here
VA41	5.000	127.00	1.063	26.99	32.72	831.11	2.54	3.78	2.2		click here
VA51	5.046	128.17	2.266	57.56	52.76	1340.10	4.21	6.27	1.4		click here
VA52	5.000	127.00	2.250	57.15	55.19	1401.78	4.02	5.99	1.2		click here
VA53	5.000	127.00	2.250	57.15	43.90	1114.93	4.92	7.32	1.5		click here
VA54	5.000	127.00	2.000	50.80	49.49	1256.94	6.39	9.50	1.4		click here
VA61	5.000	127.00	2.500	63.50	55.30	1404.67	5.58	8.30	1.38		click here
VA63	7.000	177.80	2.750	69.85	76.15	1934.11	9.87	14.69	0.9		click here
VA64	5.000	127.00	2.000	50.80	51.74	1314.25	6.51	9.68	1.4		click here
VA71	7.000	177.80	3.125	79.38	88.11	2237.89	8.15	12.13	0.86		click here
VA81	9.063	230.19	2.859	72.63	99.62	2530.22	11.62	17.30	0.74		click here
VA91	9.797	248.84	2.900	73.66	99.35	2523.36	10.70	15.93	0.73		click here
VA92	9.815	249.30	2.859	72.62	104.86	2663.44	12.79	19.03	0.71		click here
VA94	9.500	241.30	3.550	90.17	106.65	2708.86	21.43	31.88	0.7		click here
VA96	12.563	319.09	3.500	88.90	157.01	3988.08	20.28	30.18	0.5		click here
VM25575	5.750	146.05	2.500	63.50	76.87	1952.60	7.50	11.16	0.9		click here
VM26049	4.750	120.65	2.625	66.68	44.32	1125.75	2.76	4.11	1.5		click here
VM45047	4.750	120.65	4.500	114.30	69.74	1771.29	4.09	6.09	1.1		click here
VM63063	6.250	158.75	6.250	158.75	103.01	2616.45	7.65	11.38	0.72		click here

NOTES:

- Thermal resistance is calculated based on a single 1"(25.4mm) square heat source centered on the heat sink. If you have distributed loads, then you can expect 10% better performance in natural convection and 20% better performance in forced convection.
 * Thermal resistance is based on a 75°C rise in natural convection and models without finish
 ** Thermal resistance is based on fully ducted heatsink in forced convection

VA3

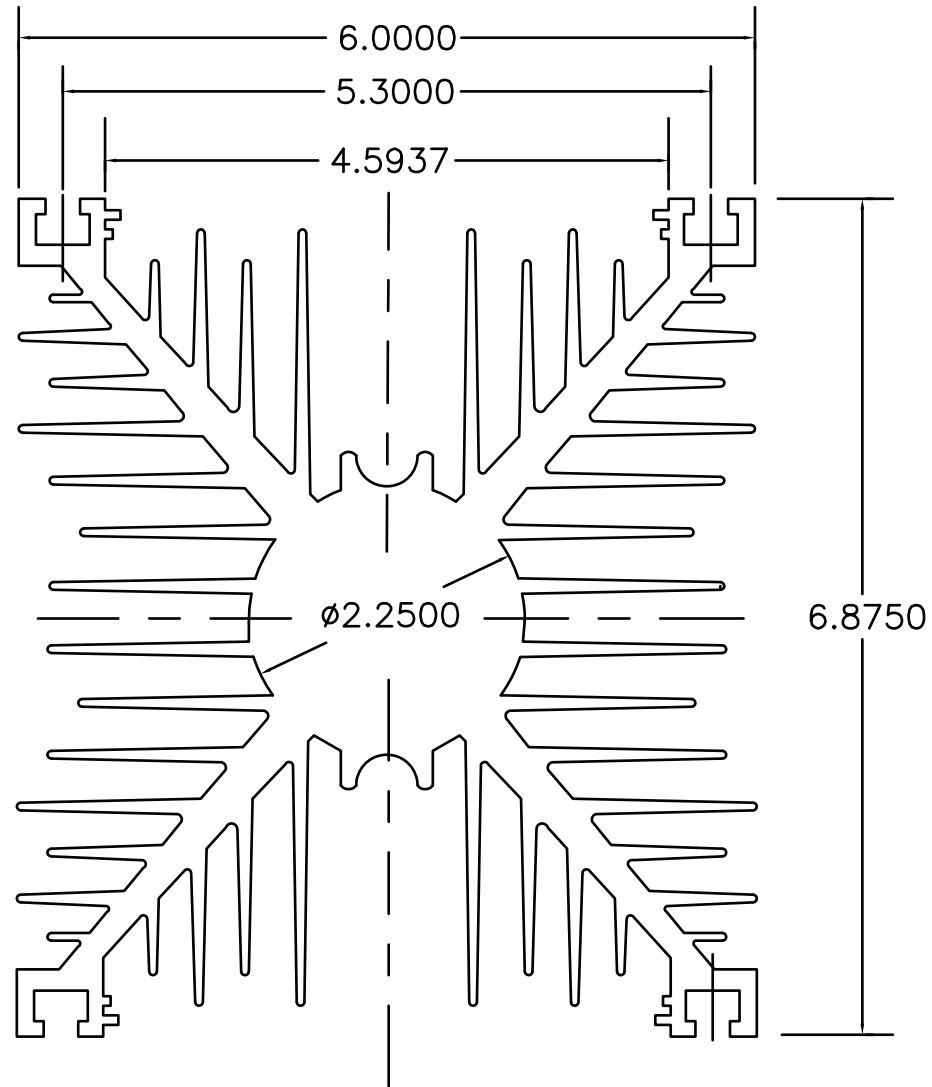

BACK

VA31

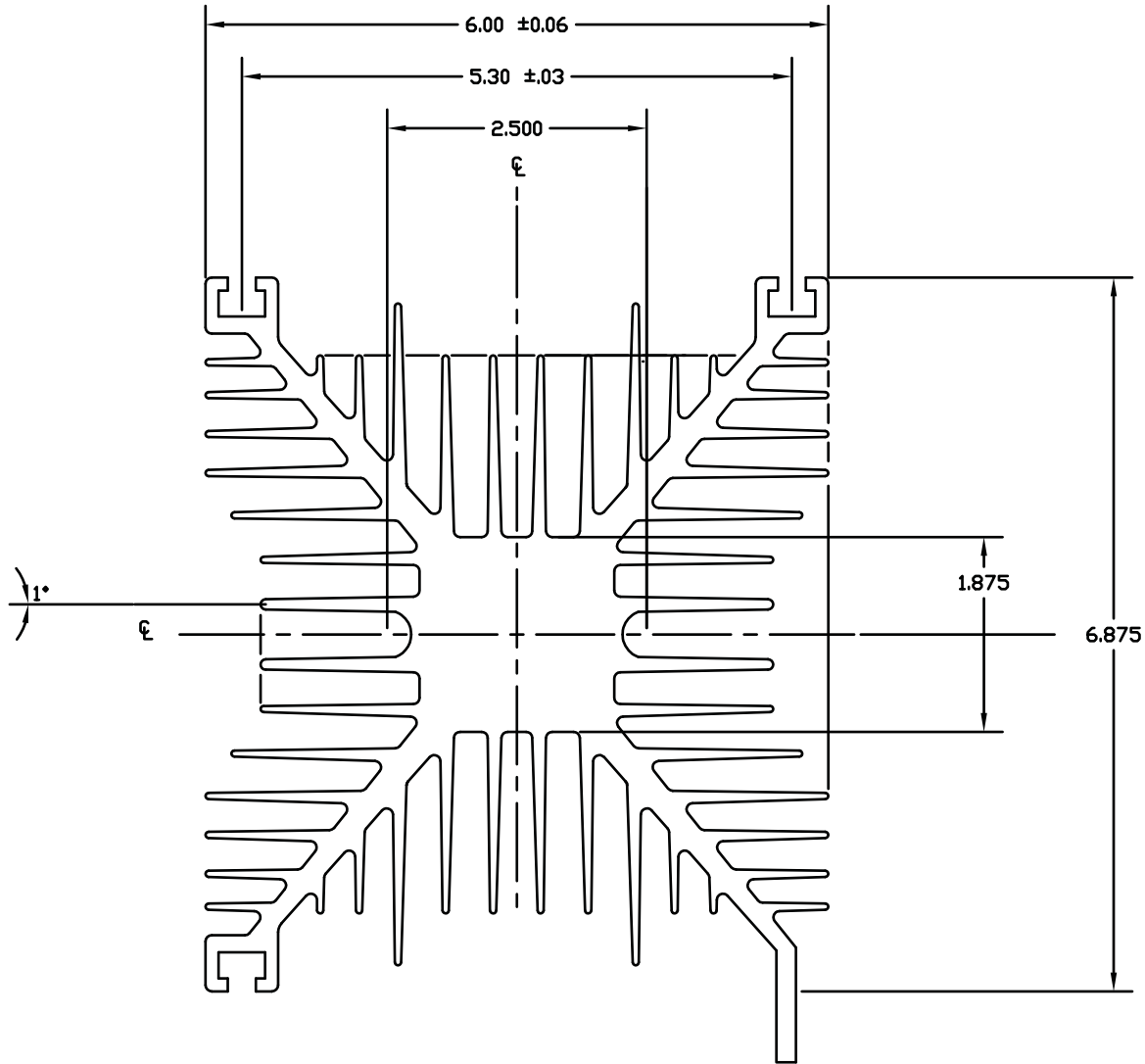

BACK

VA32

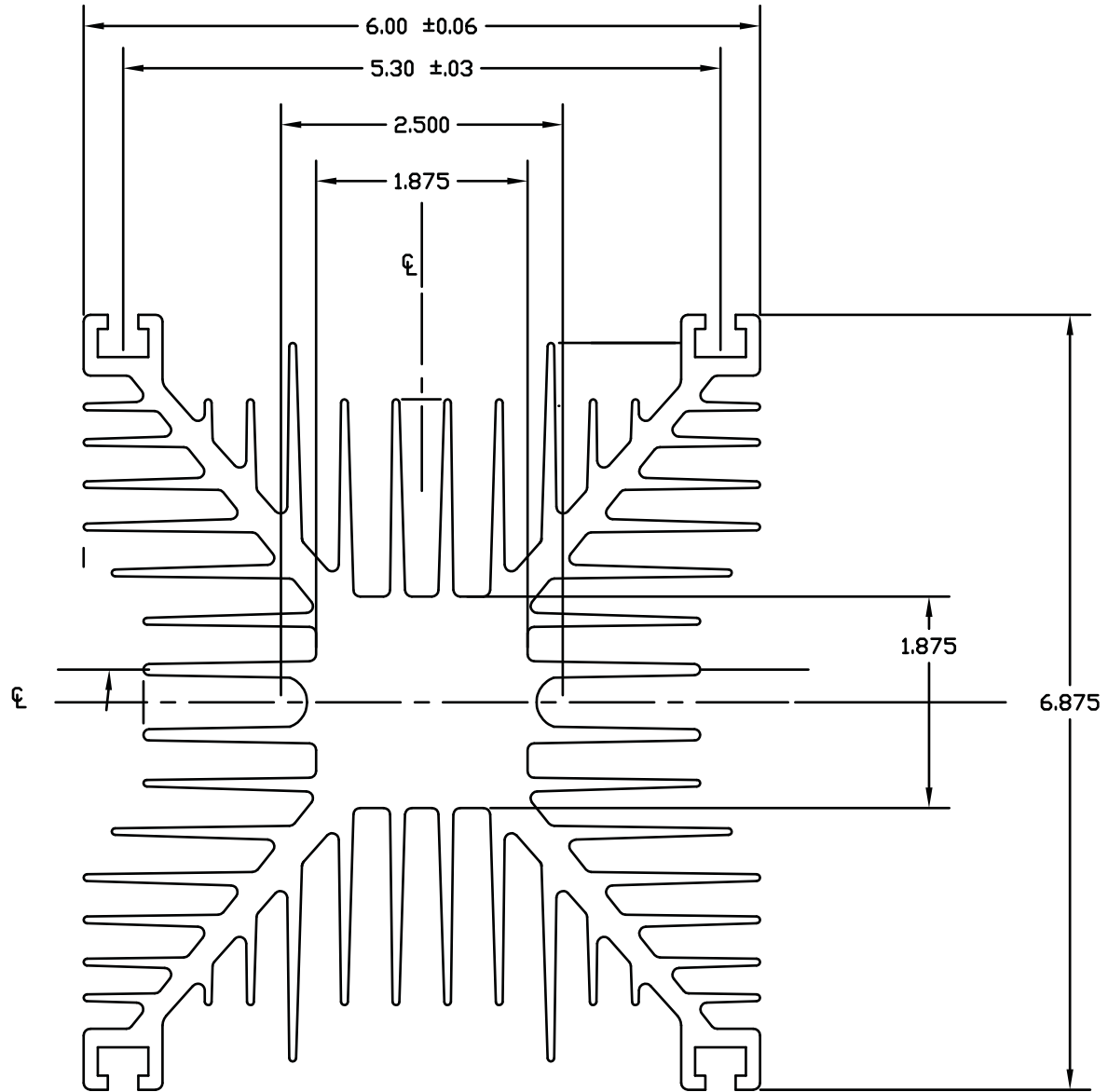

BACK

VA41

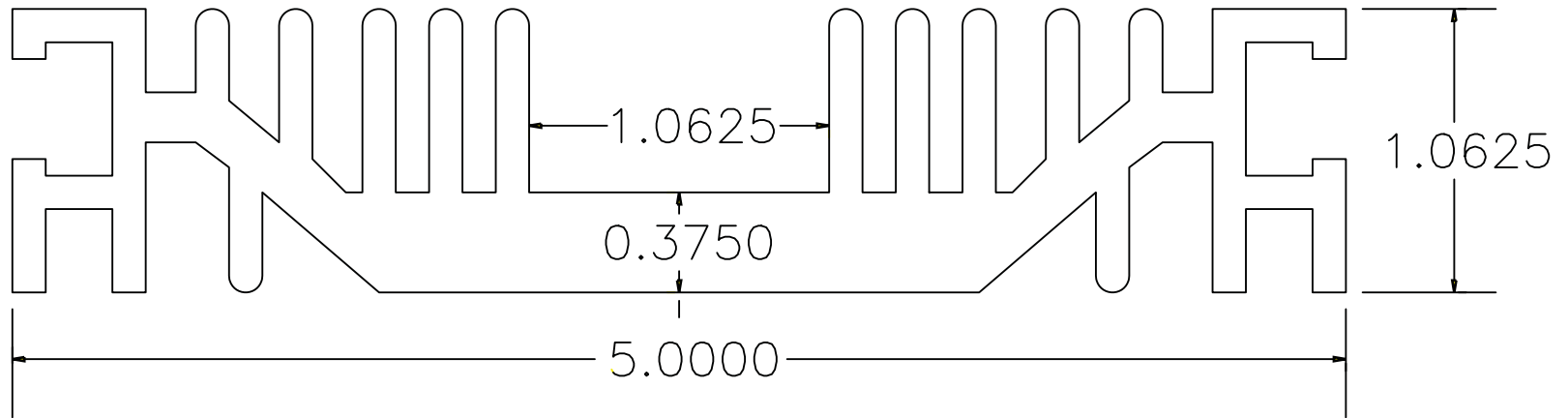

BACK

VA51

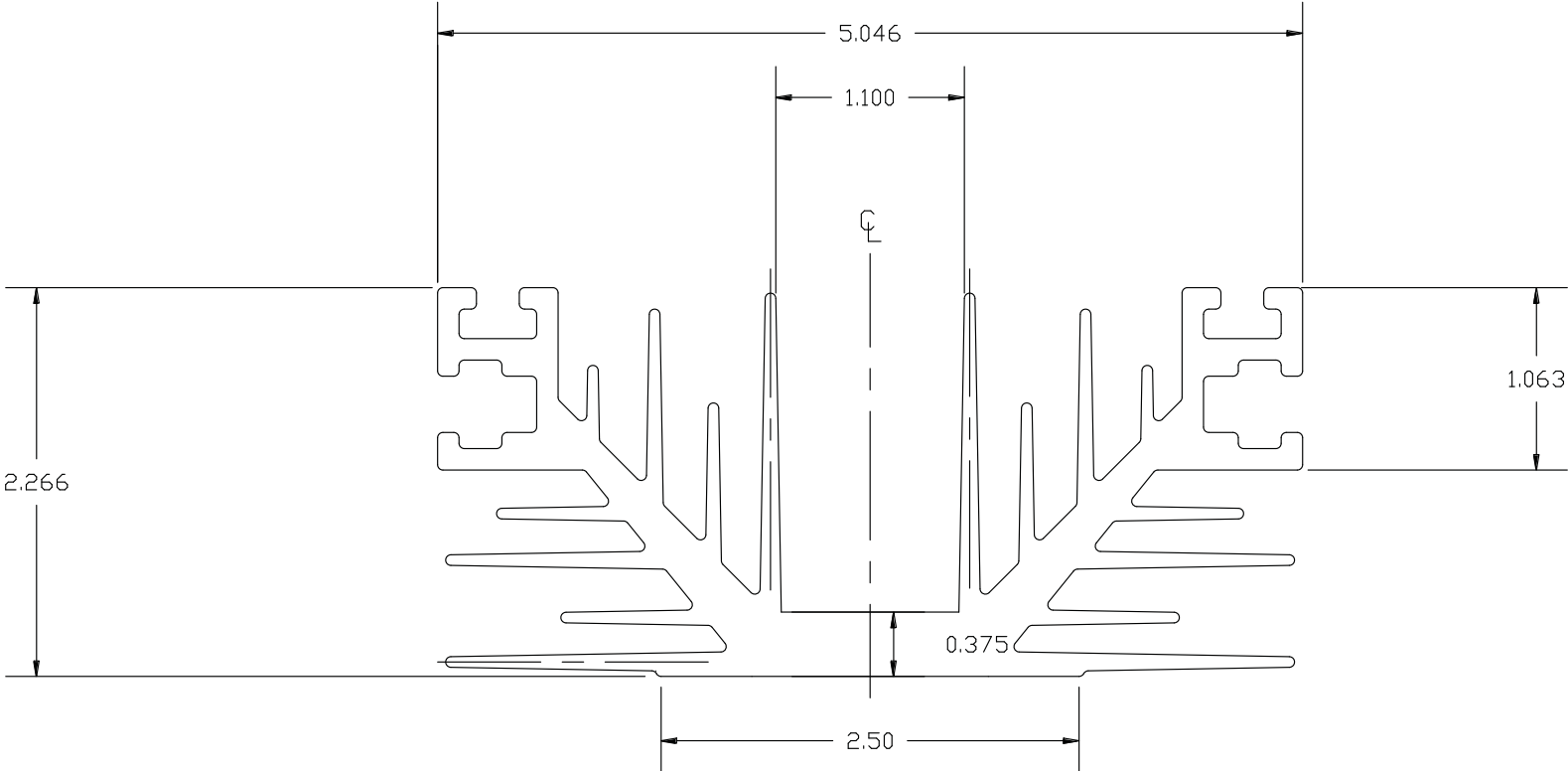

BACK

VA52

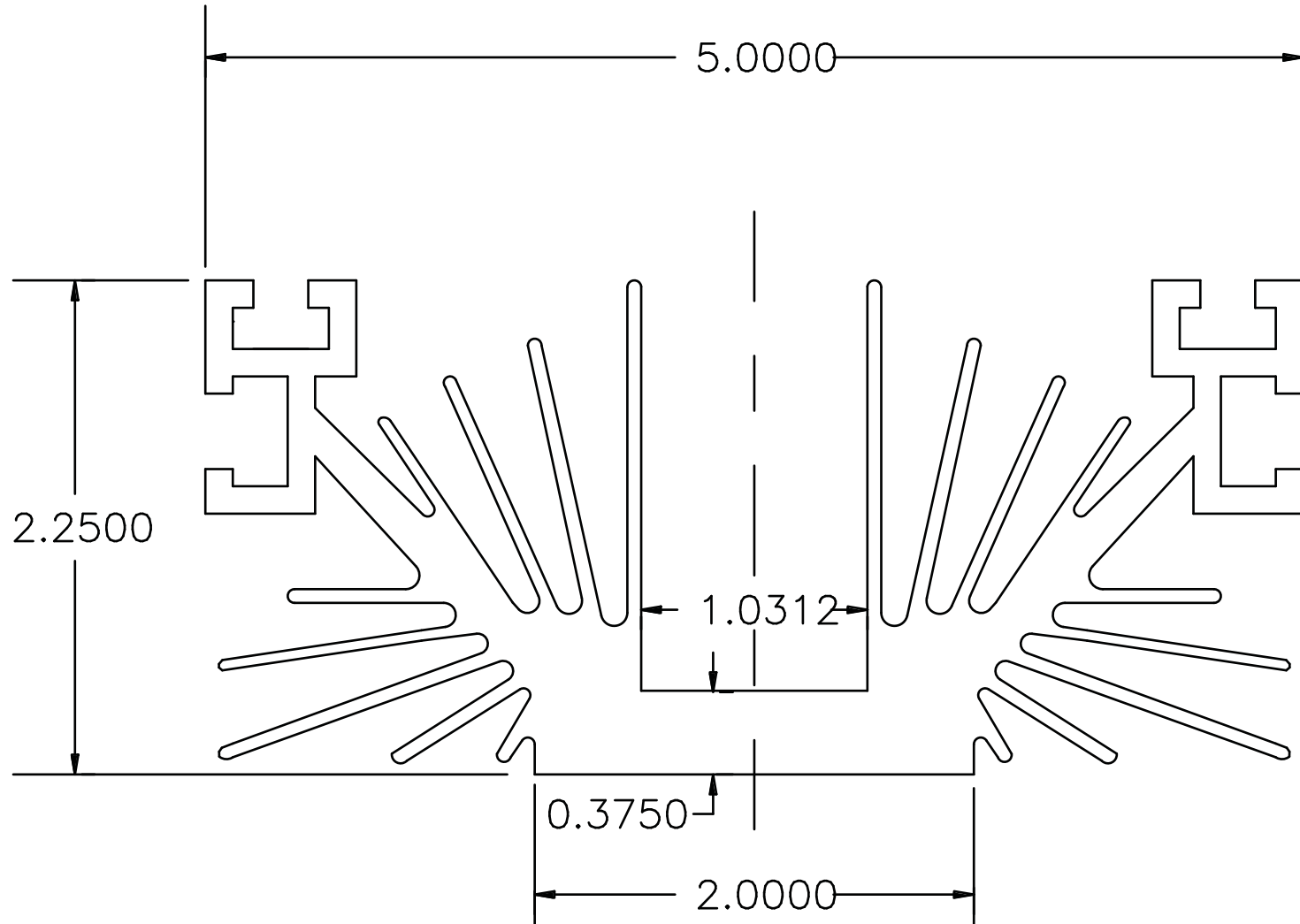

BACK

VA53

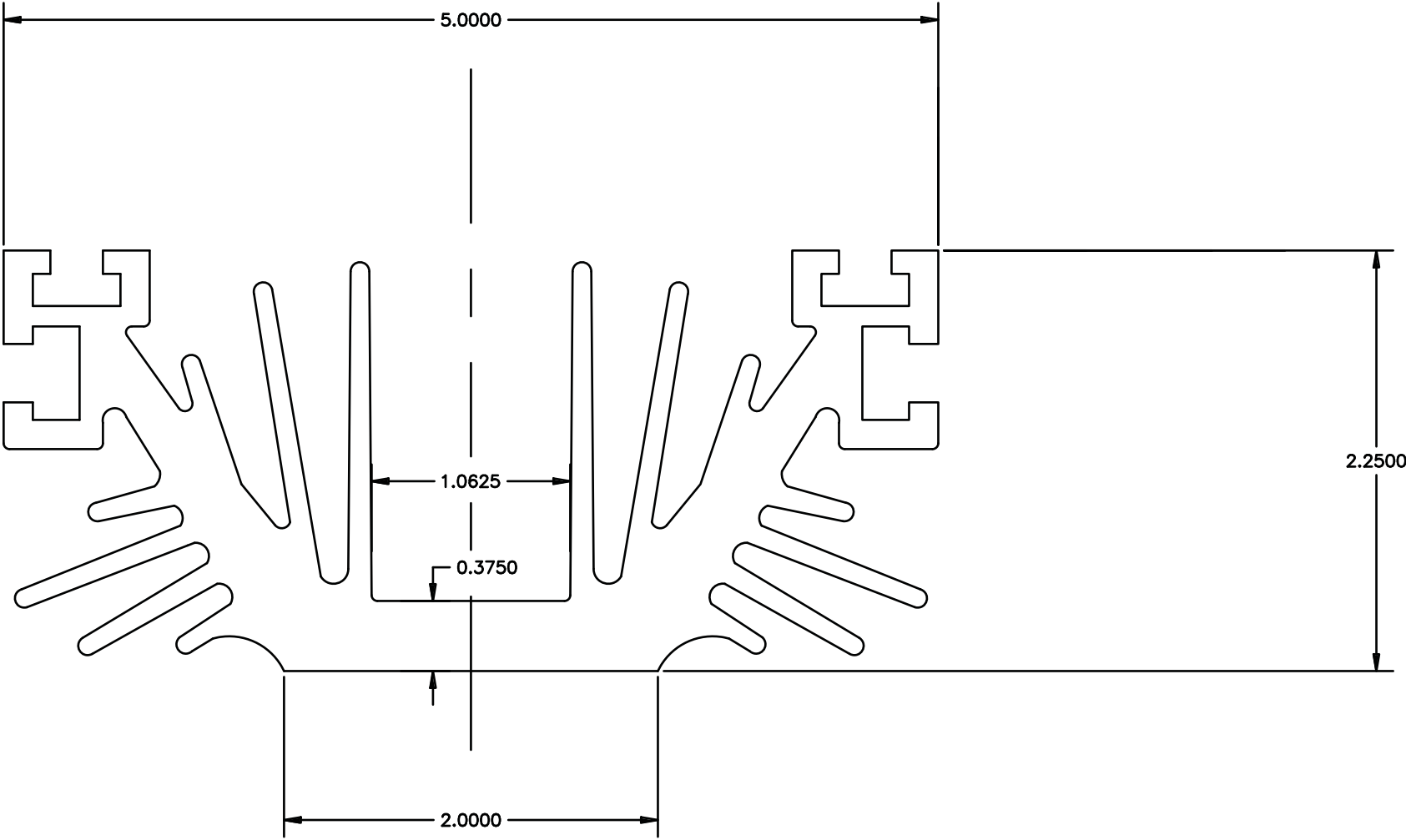

BACK

VA54

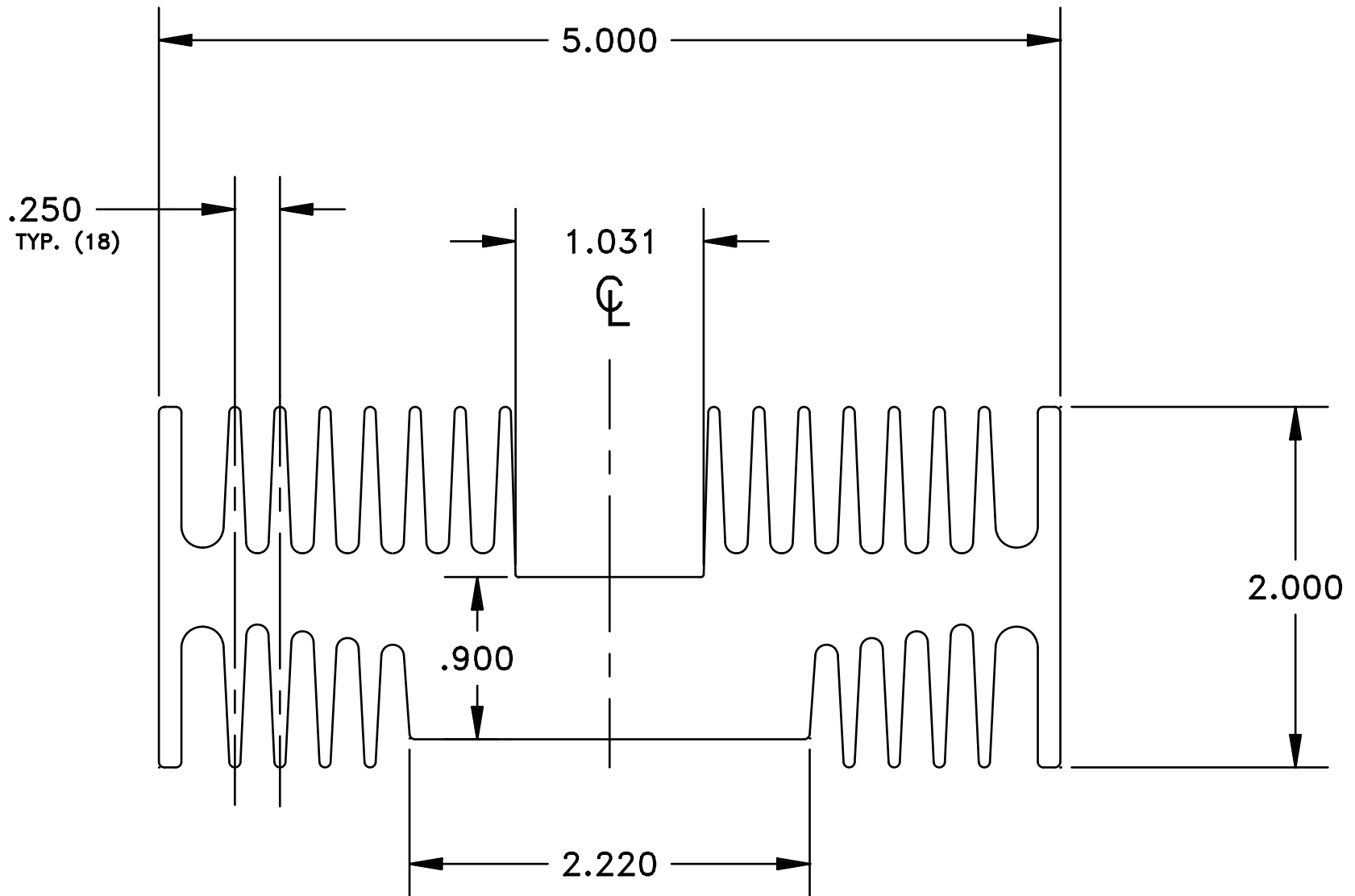

BACK

VA61

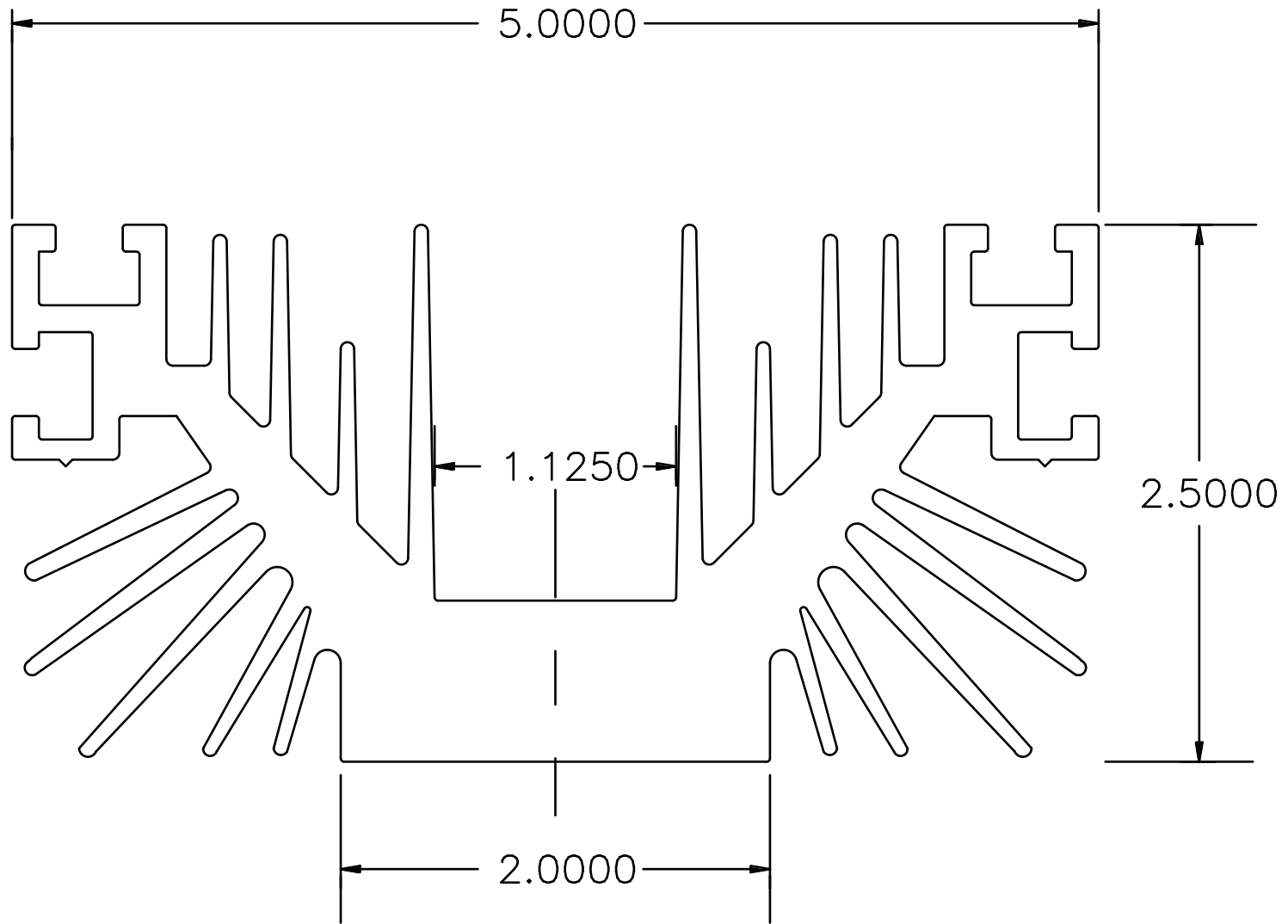

BACK

VA63

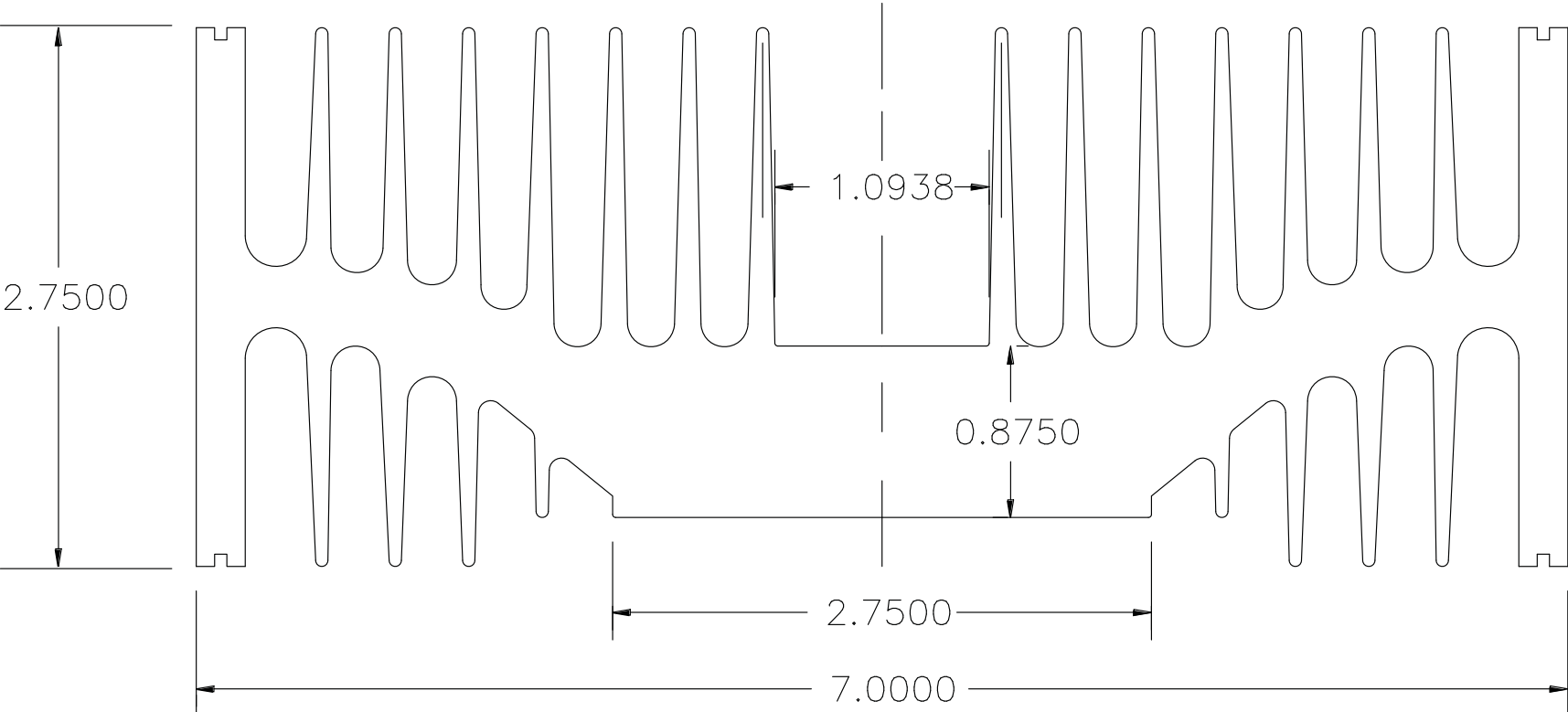

BACK

VA64

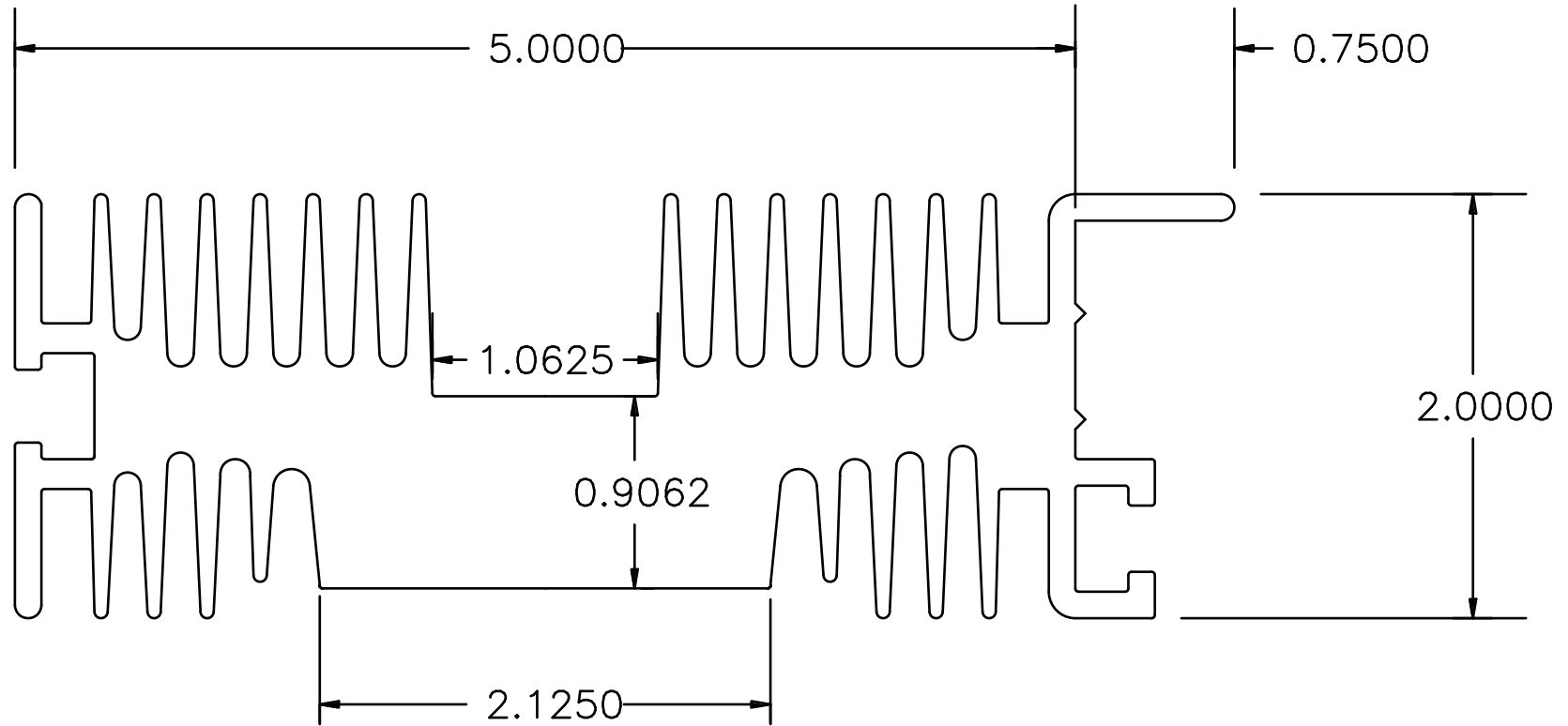

BACK

VA71

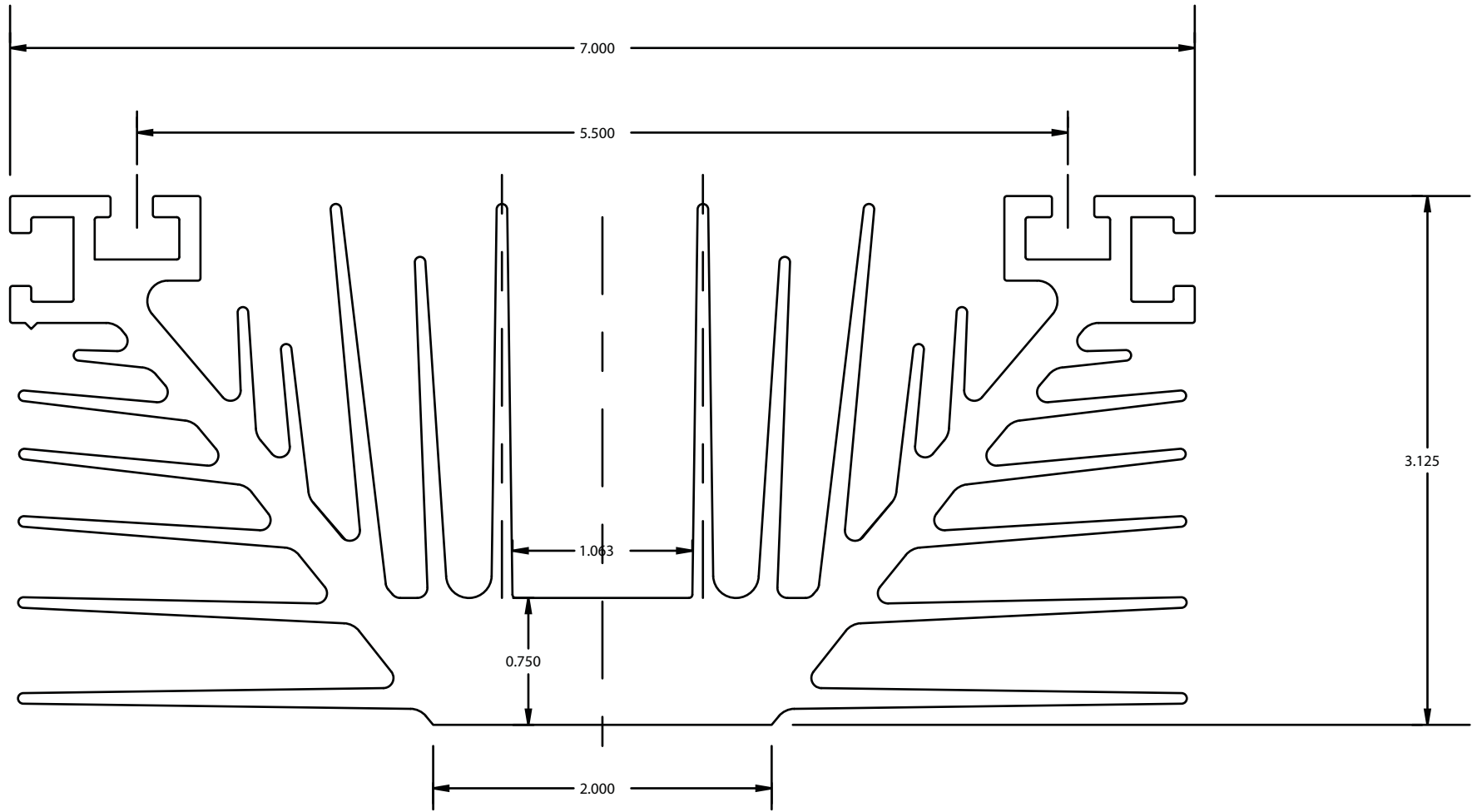

BACK

VA81

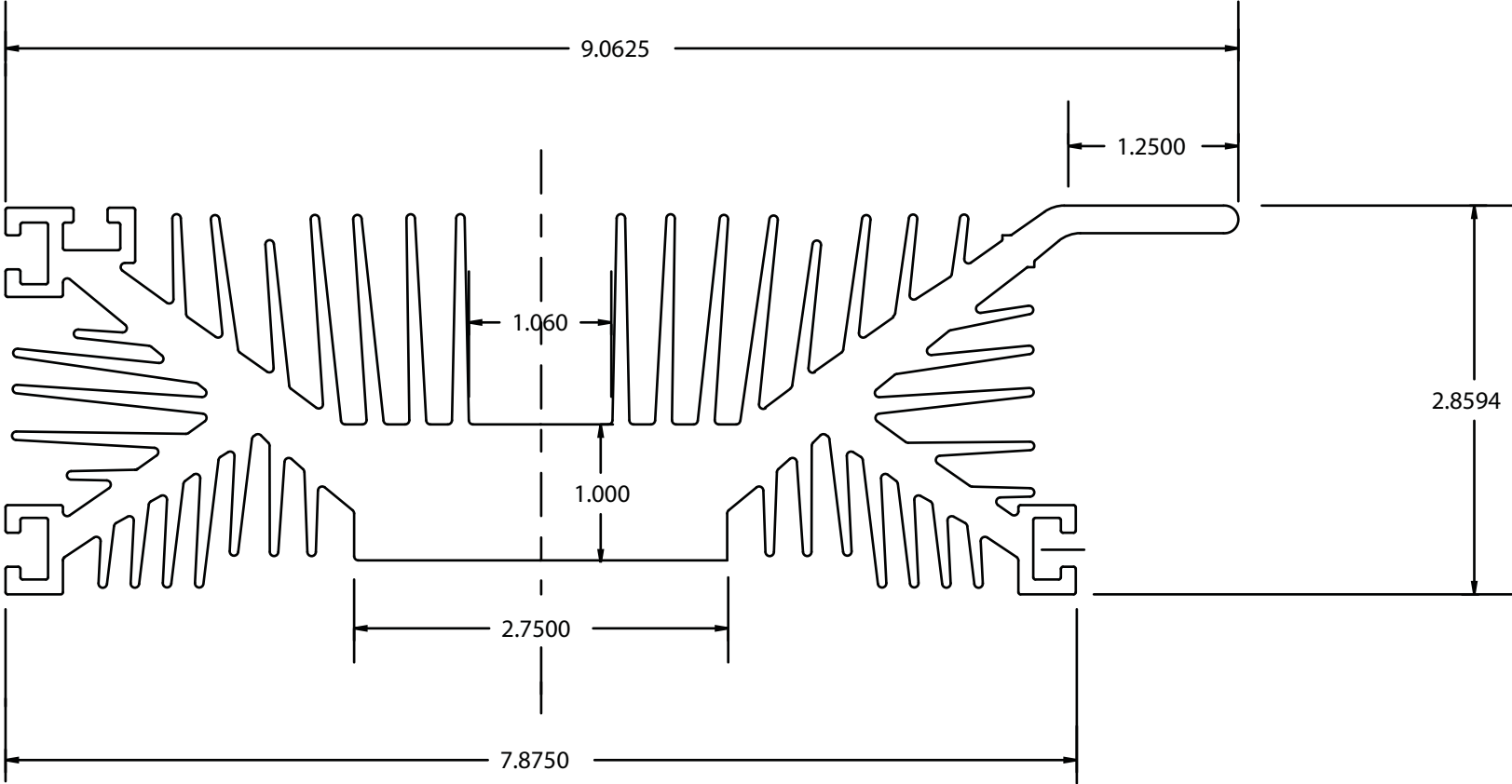

BACK

VA91

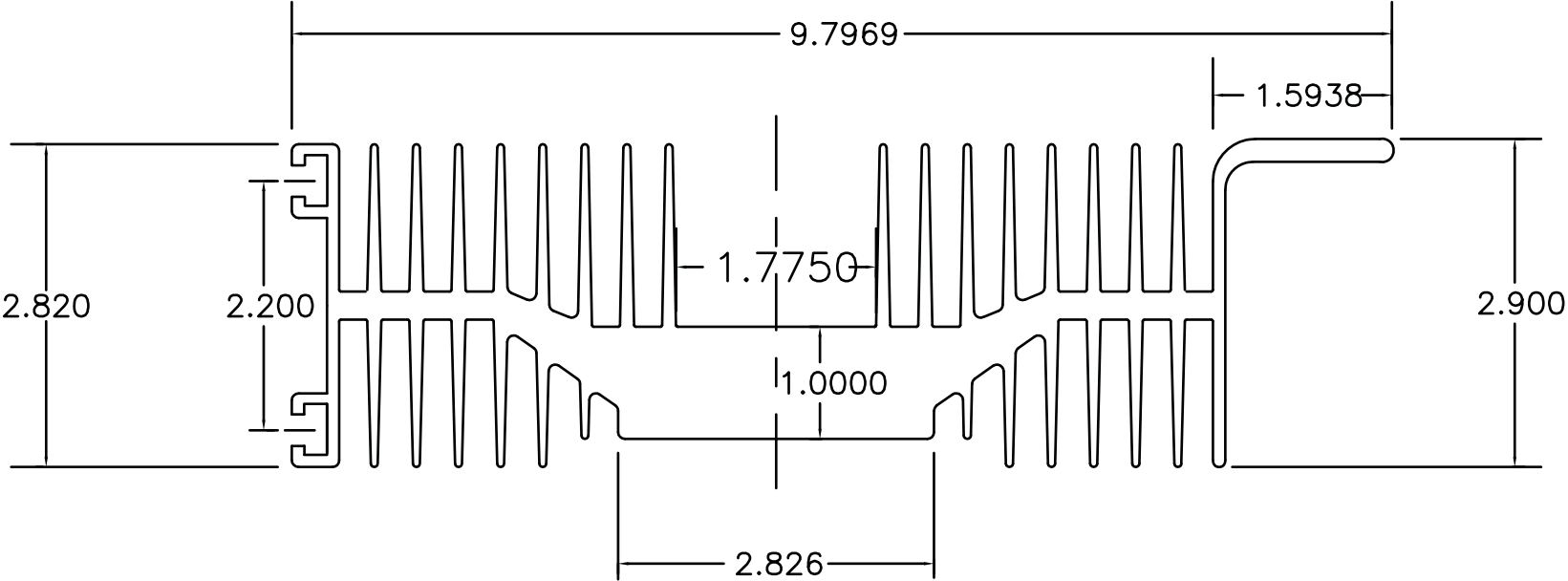

VA92

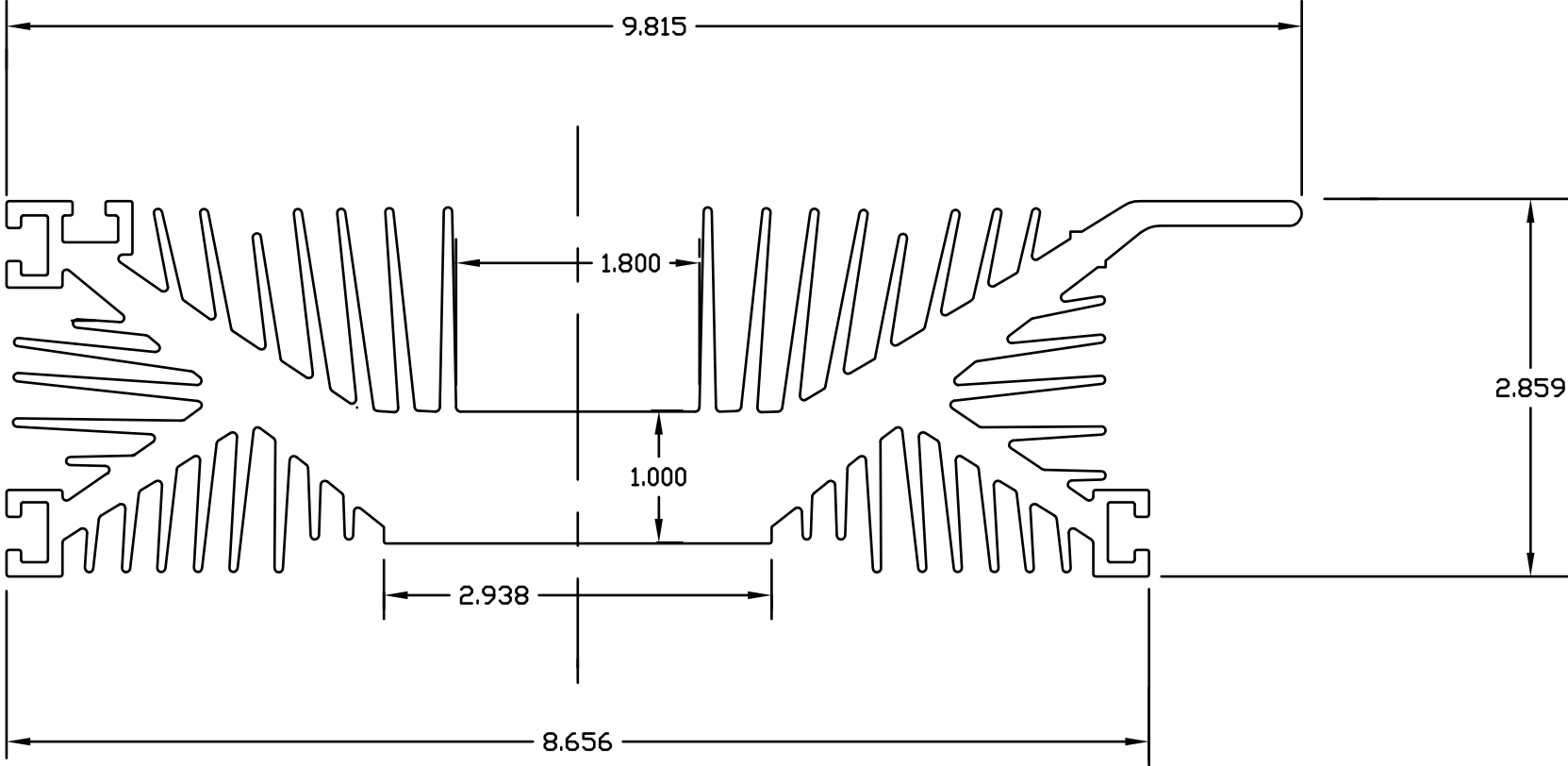

BACK

VA94

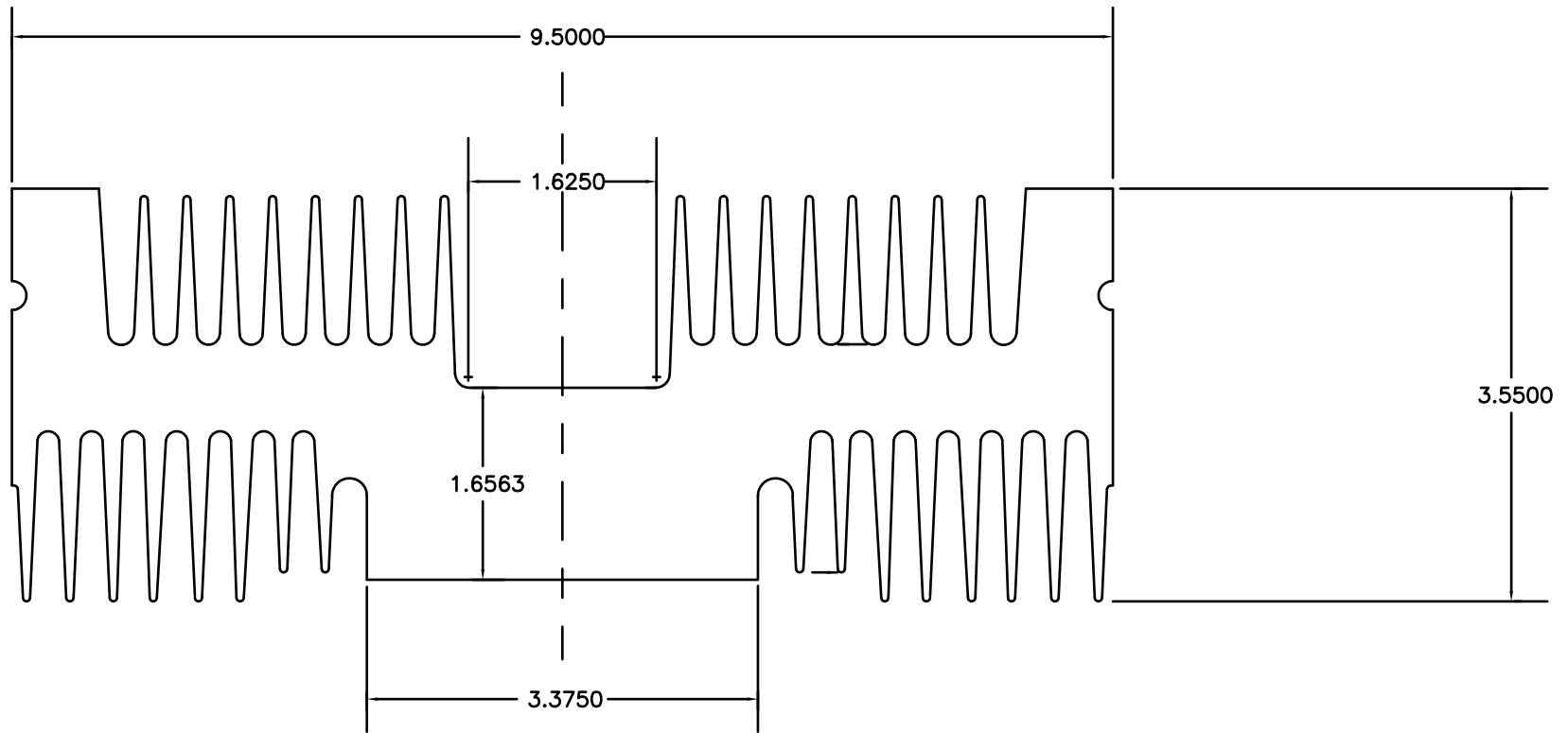

BACK

VA96

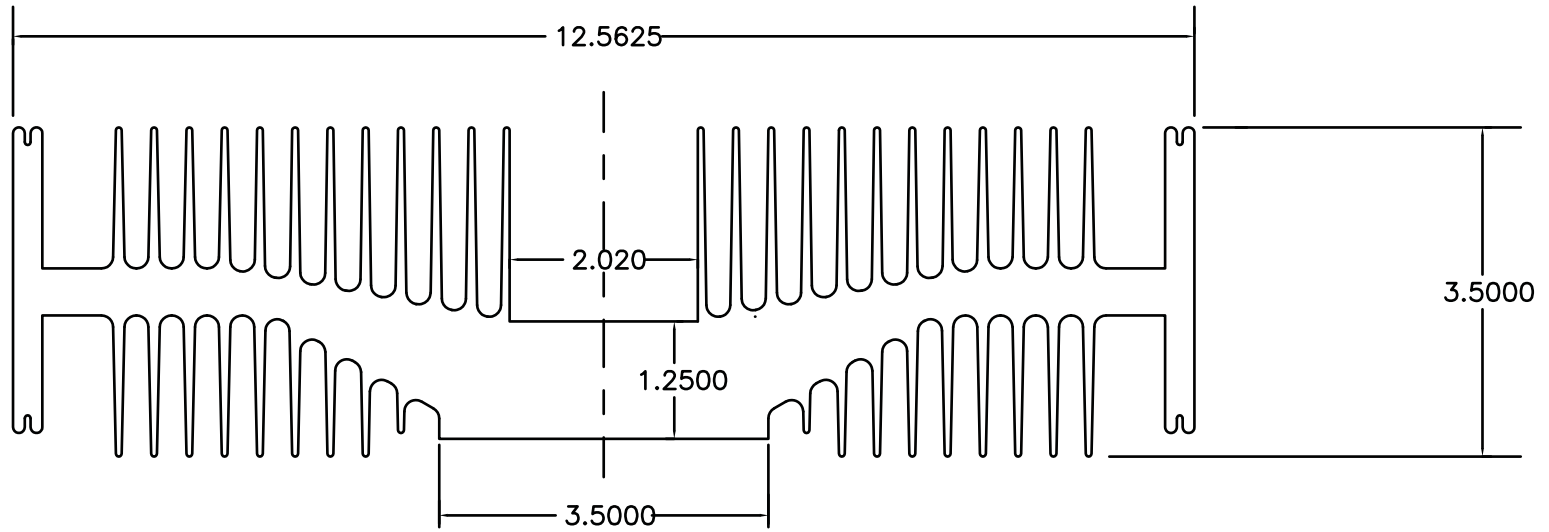

BACK

VM25575

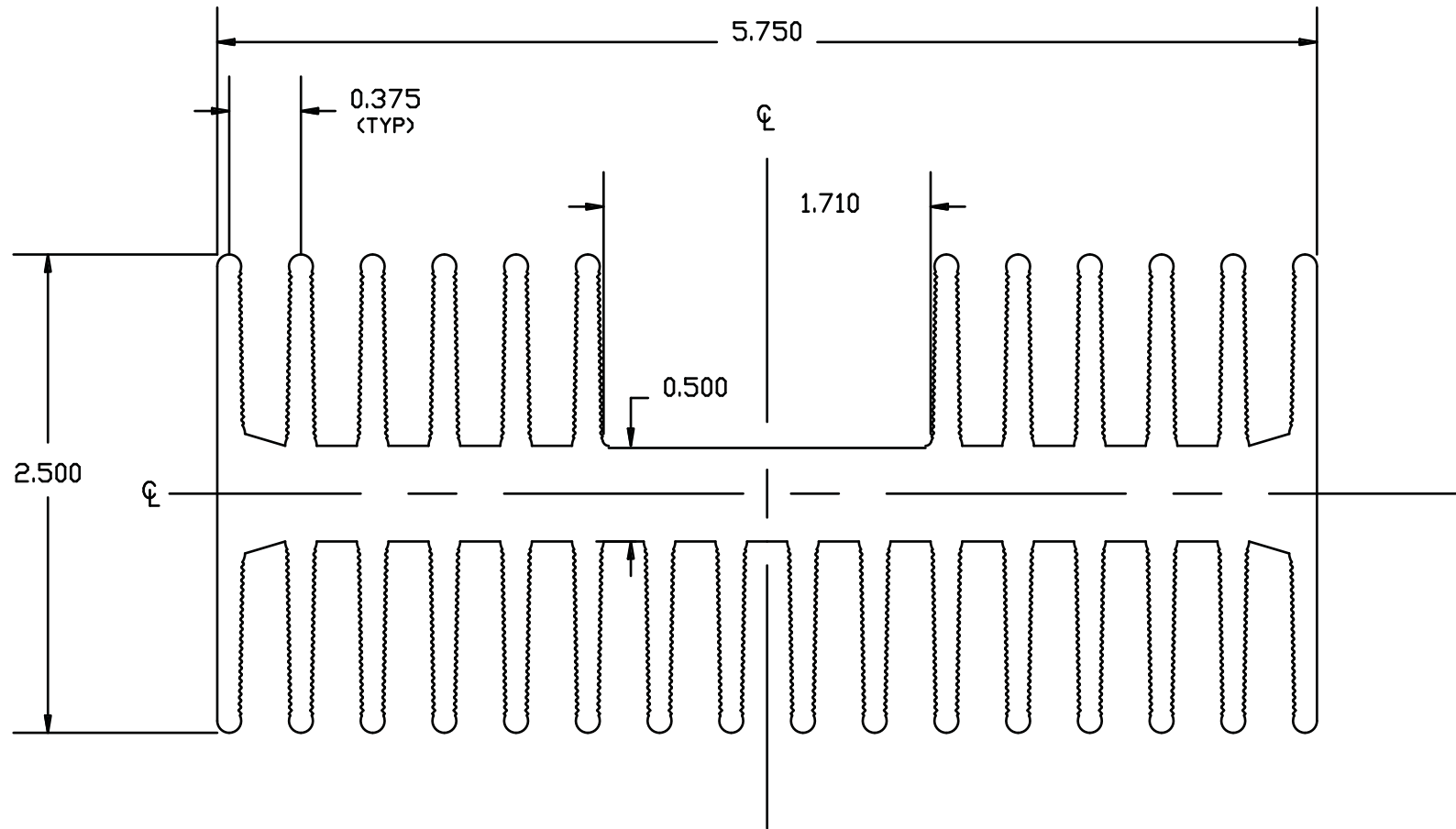

BACK

VM26049

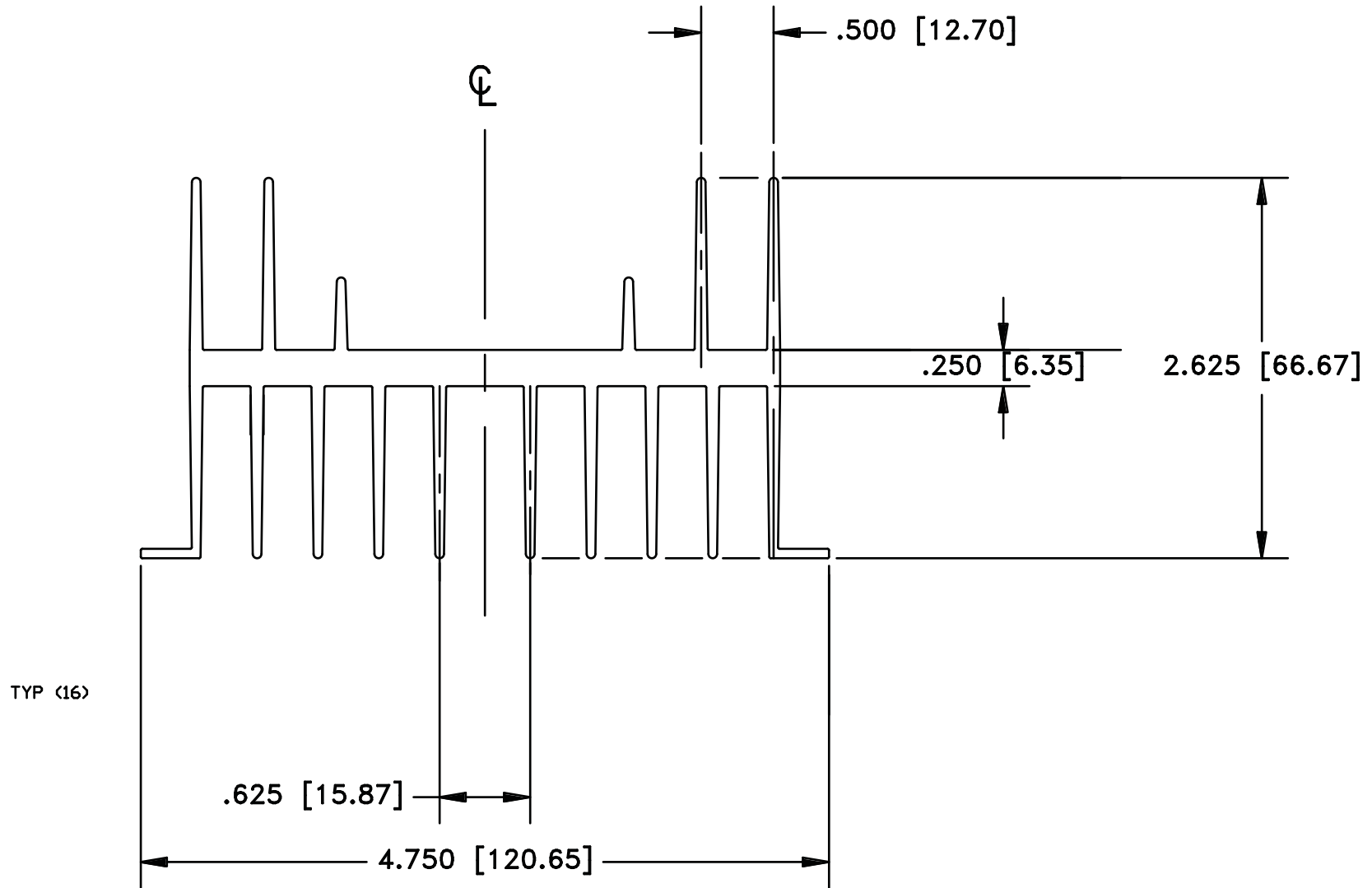

BACK

VM45047

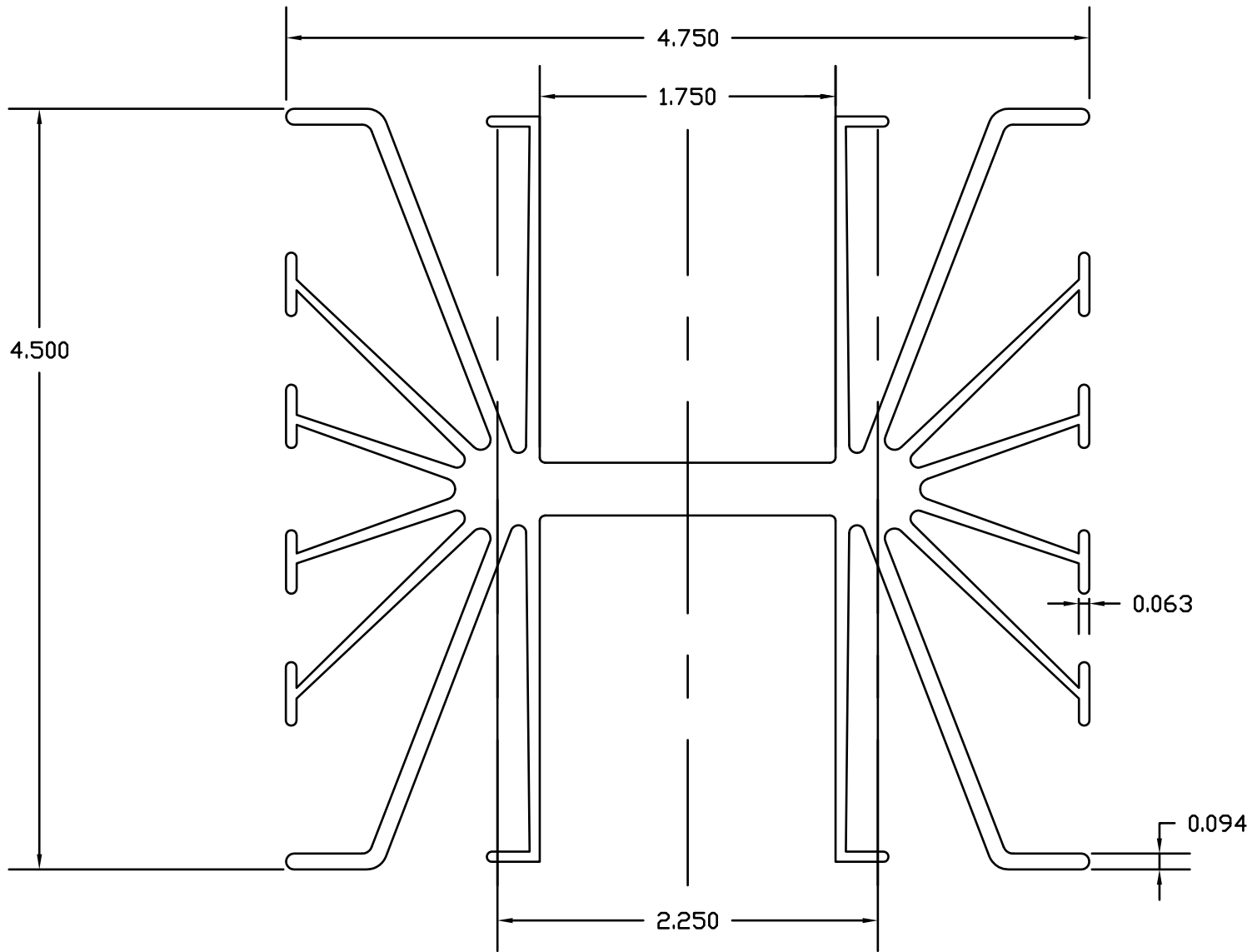

BACK

VM63063

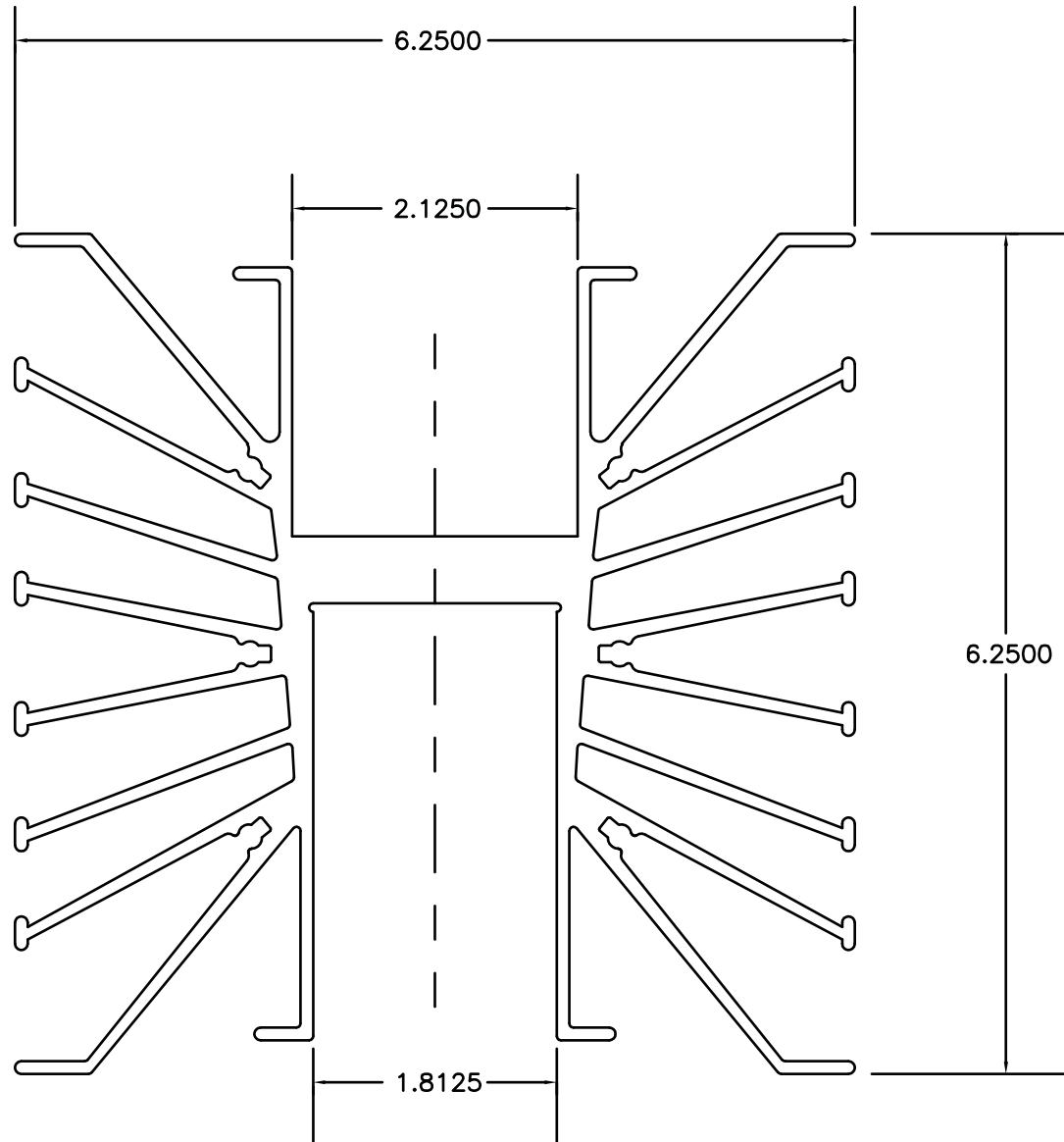

BACK